

# OUTLINE DIMENSIONAL DRAWING

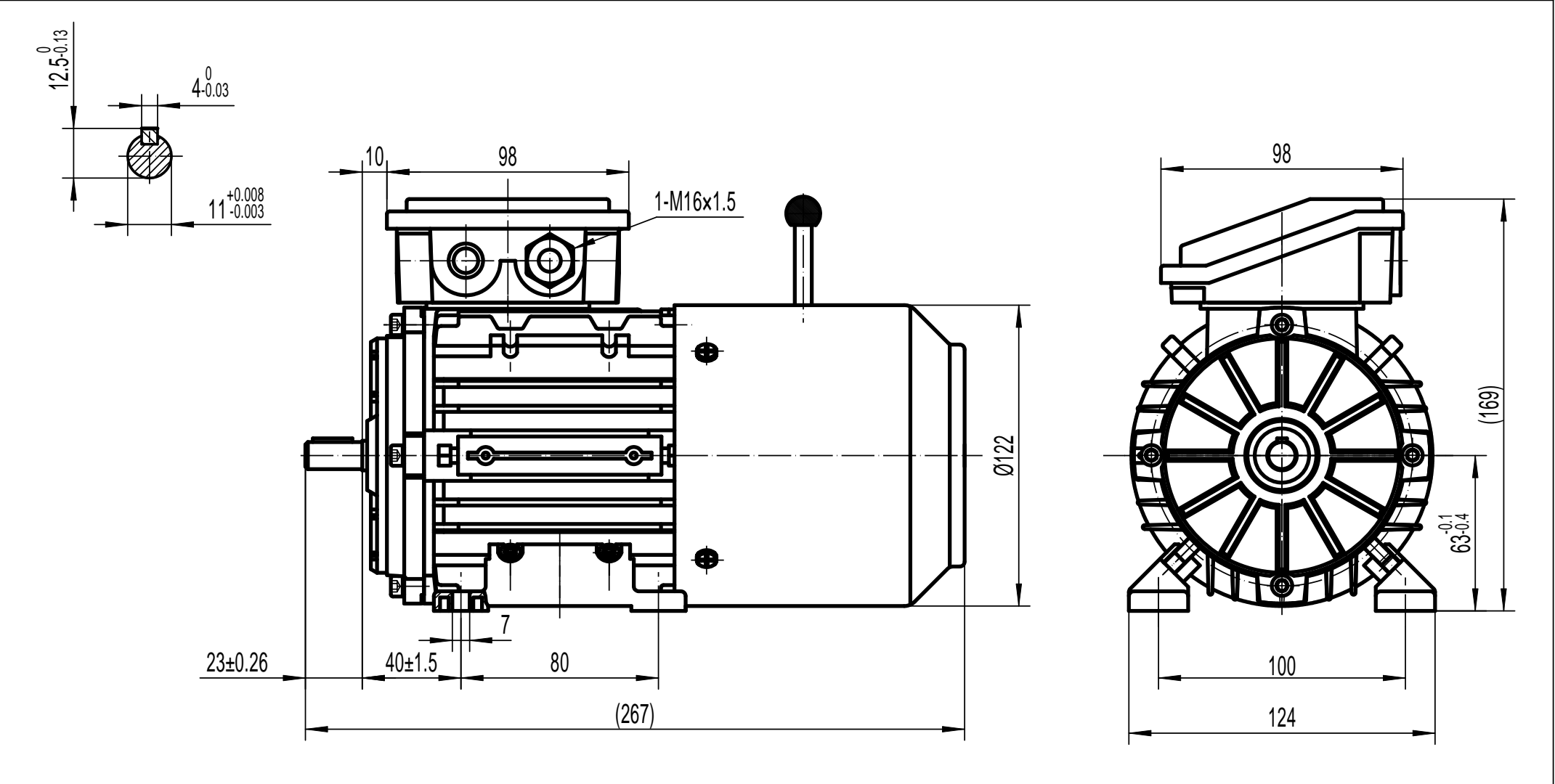

TECHTOP AUSTRALIA PTY LTD	
FRAME	TAIB 63A B3
DATE	DRAWING NO.
2013/10/22	1ST0100.050.001-010 A